



# TRL Series Metal Film Low-Resistance Chip Resistor Product Specifications

Document No.	S-10-12-13-11
Released Date	2020/4/07
Page No.	1/15

## ■ Metal Film Low-Resistance Chip Resistor — TRL Series

Standard Type

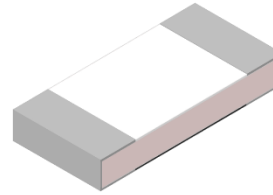
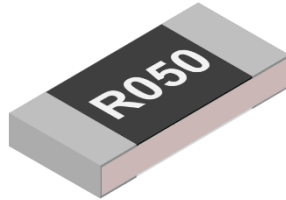

Wide Terminal Type

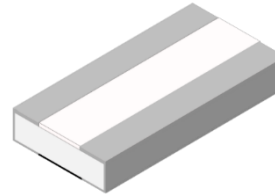

Top view

Bottom view

### ■ Applications

- Consumer electronics
- Computer & relative products
- Communication devices
- Measuring instrument
- Industrial / Power supply
- Battery management system

### ■ Features

- Low Resistance / TCR / Inductance
- Excellent long-term stability
- High precision current sensing
- High power capability
- Halogen free and lead free
- RoHs compliant

### ■ Parts Number Explanation

#### ■ Example:

TRL	1206	05	F	R560	P	05	Z
Product Type	Size (Inch)	Rated Power	Tolerance	Resistance	Package	Quantity (PCS)	Optional
Metal Film Low-Resistance Chip Resistors	0201 0402 0603 0805 1206 1210 2010 2512	Y5 : 0.05W Y6 : 0.063W 01 : 0.10W X1 : 0.125W 02 : 0.20W X2 : 0.25W 04 : 0.40W 05 : 0.50W 07 : 0.75W 10 : 1.0W 15 : 1.5W 20 : 2.0W 30 : 3.0W	D : ±0.5% F : ±1% G : ±2% J : ±5%	EX. R056 = 0.056 Ω R560 = 0.56 Ω 1R00 = 1 Ω	P : Paper Taping (0603~1210) Q : Paper Taping (0201、0402) E : Embossed Taping B : Bulk	04 : 4000 05 : 5000 10 : 10000	Z : Default code



**TRL Series Metal Film Low-Resistance Chip Resistor Product Specifications**

<b>Document No.</b>	S-10-12-13-11
<b>Released Date</b>	2020/4/07
<b>Page No.</b>	2/15

■ **Standard Electrical Specifications**

■ **Standard Type:**

Type	Rated Power at 70°C	Max. Rated Current	Max. Overload Current	T.C.R. (ppm/°C)	Resistance Range	
					C(0.25%)	D(0.5%), F(1.0%), G(2.0%), J(5.0%)
TRL0201	1/20W	1.00A	2.50A			
	1/10W	1.41A	3.16A			
	1/5 W	2.00A	4.47A			
TRL0402	1/16W	1.12A	2.80A	±100	-	50 mΩ ≤ R < 100 mΩ
	1/8W	1.58A	3.54A	-----		-----
	1/4W	2.24A	5.00A	±50		100 mΩ ≤ R ≤ 10 Ω
TRL0603	1/10W	1.41A	3.54A			
	1/5W	2.00A	4.47A			
	2/5W	2.83A	6.32A			
TRL0805	1/8W	1.79A	4.48A	±150	-	39 mΩ ≤ R < 50 mΩ
	1/4W	2.53A	5.66A	-----		-----
	1/2W	3.58A	8.00A	±100		50 mΩ ≤ R < 100 mΩ
TRL1206	1/4W	2.53A	6.33A	±150	-	39 mΩ ≤ R < 50 mΩ
	1/2W	3.58A	8.00A	-----		-----
	1W	5.06A	11.32A	±100		50 mΩ ≤ R < 100 mΩ
TRL1210	1/2W	3.58A	8.95A	-----	470 mΩ ≤ R ≤ 10 Ω	100 mΩ ≤ R ≤ 10 Ω
	1W	5.06A	11.32A	±50		
TRL2010	3/4W	2.74A	6.85A			
	1.5W	3.87A	8.66A			
TRL2512	1W	3.16A	7.91A	±50	470 mΩ ≤ R ≤ 10 Ω	100 mΩ ≤ R ≤ 10 Ω
	2W	4.47A	10.00A			
	3W	5.48A	12.25A			



# TRL Series Metal Film Low-Resistance Chip Resistor Product Specifications

Document No.	S-10-12-13-11
Released Date	2020/4/07
Page No.	3/15

Type	Rated Power at 70°C	Max. Rated Current	Max. Overload Current	T.C.R. (ppm/°C)	Resistance Range
					F(1.0%), G(2.0%), J(5.0%)
TRL1206	1/4W	5.00A	12.50A	±200	10 mΩ ≤ R < 39 mΩ
	1/2W	7.07A	15.81A		

## Wide Terminal Type:

Type	Rated Power at 70°C	Max. Rated Current	Max. Overload Current	T.C.R. (ppm/°C)	Resistance Range			
					D (0.5%)	F (1.0%)	G (2.0%)	J (5.0%)
TRL0612	1W	10.00A	22.36A	±150	-	10mΩ ≤ R < 20mΩ		
				±100	100mΩ ≤ R ≤ 500mΩ	20mΩ ≤ R ≤ 500mΩ		
TRL1020	2W	14.14A	31.62A	±150	-	10mΩ ≤ R < 20mΩ		
				±100	100mΩ ≤ R ≤ 500mΩ	20mΩ ≤ R ≤ 500mΩ		
TRL1225	3W	17.32A	38.73A	±150	-	10mΩ ≤ R < 20mΩ		
				±100	100mΩ ≤ R ≤ 500mΩ	20mΩ ≤ R ≤ 500mΩ		

- For non-standard parts, please contact our sales dept.
- Operating Temperature Range : -55°C ~ +155°C.

## Type Dimensions

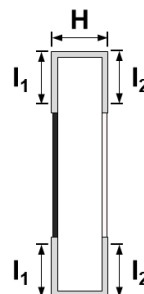
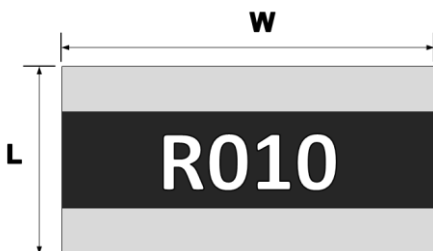
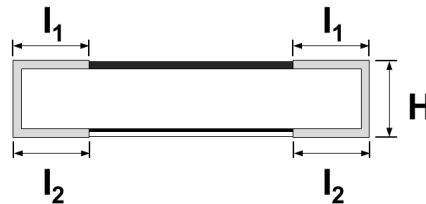
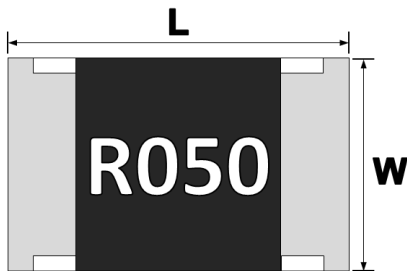



**TRL Series Metal Film Low-Resistance Chip Resistor Product Specifications**

Document No. S-10-12-13-11  
 Released Date 2020/4/07  
 Page No. 4/15

Unit : mm

TYPE	L	W	H	l <sub>1</sub>	l <sub>2</sub>
TRL0201	0.60±0.03	0.30±0.03	0.26±0.05	0.15±0.05	0.15±0.05
TRL0402	1.00±0.10	0.50±0.05	0.35±0.05	0.20±0.10	0.25±0.10
TRL0603	1.60±0.10	0.80±0.10	0.45±0.10	0.25±0.15	0.30±0.15
TRL0805	2.00±0.10	1.25±0.10	0.55±0.10	0.35±0.20	0.40±0.20
TRL1206	3.10±0.10	1.60±0.10	0.55±0.10	0.40±0.20	0.45±0.20
TRL1210	3.10±0.10	2.50±0.15	0.55±0.10	0.50±0.20	0.50±0.20
TRL2010	5.00±0.20	2.50±0.15	0.55±0.10	0.60±0.25	0.60±0.25
TRL2512	6.30±0.20	3.20±0.20	0.55±0.10	0.65±0.25	0.65±0.25
TRL2512(3W)	6.30±0.20	3.20±0.20	0.70±0.15	0.65±0.25	0.65±0.25
TRL0612	1.60±0.15	3.20±0.20	0.55±0.15	0.30±0.20	0.50±0.20
TRL1020	2.50±0.15	5.00±0.15	0.55±0.15	0.40±0.20	0.50±0.20
TRL1225	3.20±0.20	6.30±0.20	0.55±0.15	0.60±0.25	0.80±0.25

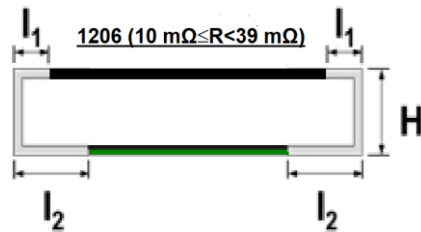
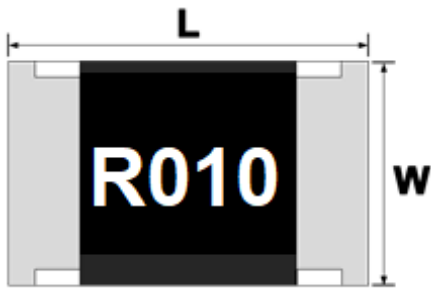

TYPE	L	W	H	l <sub>1</sub>	l <sub>2</sub>
TRL1206 (10 mΩ ≤ R < 39 mΩ)	3.30±0.20	1.70±0.20	0.65±0.2	0.20±0.15	0.68±0.20

■ **Construction**

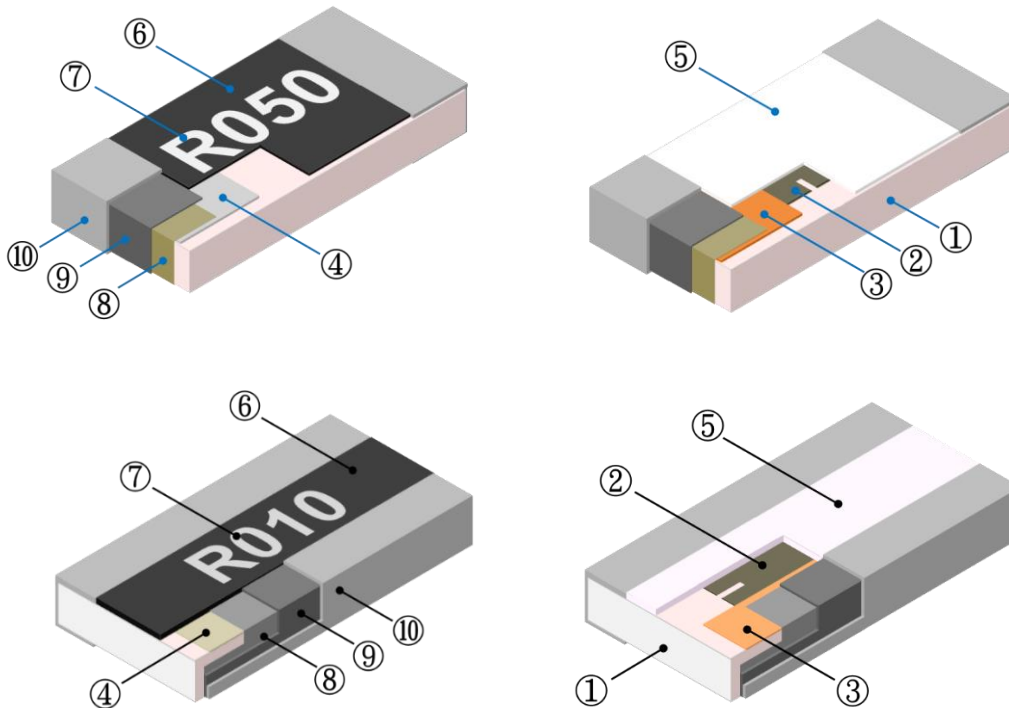

①	<b>Alumina Substrate</b>	⑥	<b>Top Protective Overcoat</b>
②	<b>Resistive Layer</b>	⑦	<b>Marking</b>
③	<b>Bottom Inner Electrode (Cu)</b>	⑧	<b>Side Inner Electrode</b>
④	<b>Top Inner Electrode</b>	⑨	<b>Barrier Layer (Ni)</b>
⑤	<b>Bottom Protective Overcoat White(<math>\geq 39\text{mR}</math>) Green(<math>&lt;39\text{mR}</math>)</b>	⑩	<b>Solder coating (Sn)</b>



# TRL Series Metal Film Low-Resistance Chip Resistor Product Specifications

Document No.	S-10-12-13-11
Released Date	2020/4/07
Page No.	6/15

## Performance Characteristics

### Power Derating Curve

The Operating Temperature Range:  $-55^{\circ}\text{C} \sim +155^{\circ}\text{C}$ .

Power rating or current rating is in the case based on continuous full-load at ambient temperature of  $70^{\circ}\text{C}$ . For operation at ambient temperature in excess of  $70^{\circ}\text{C}$ , the load should be derated in accordance with figure of derating Curve.

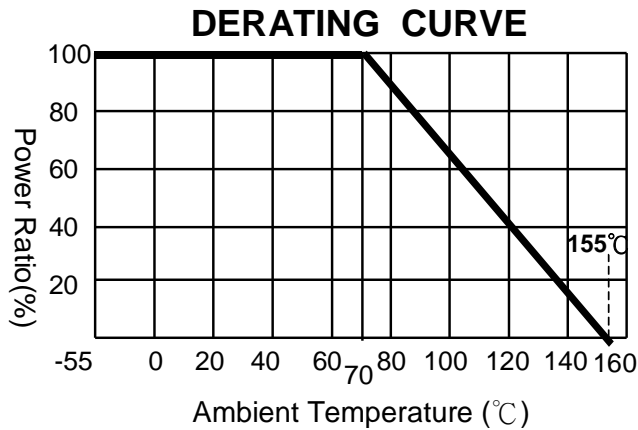

### Rated Current

Resistance Range:  $< 1\Omega$

Rated Current: The resistor shall have a DC continuous working current or a AC (rms) continuous working current at commercial-line frequency and wave form corresponding to the power rating, as determined formula as following:

$$I = \sqrt{P/R}$$

$I$  = Rated current (A)  
 $P$  = Rated Power (W)  
 $R$  = Resistance( $\Omega$ )

### Rated Voltage

Resistance Range:  $\geq 1\Omega$

Rated Voltage: The resistor shall have a DC continuous working voltage or a RMS AC continuous working voltage at commercial-line frequency and wave form corresponding to the power rating, as determined formula as following:

$$V = \sqrt{P \times R}$$

$V$  = Rated voltage (V)  
 $P$  = Rated power (W)  
 $R$  = Nominal resistance ( $\Omega$ )



# TRL Series Metal Film Low-Resistance Chip Resistor Product Specifications

Document No. S-10-12-13-11  
 Released Date 2020/4/07  
 Page No. 7/15

## ■ Reliability Tests and Requirements

Test Item	Test Method	Procedure	Requirements
Temperature Coefficient of Resistance (T.C.R)	JIS-C-5201-1 4.8 IEC-60115-1 4.8	TCR +125 °C, 25 °C is the reference temperature	Refer to Standard Electrical Specifications
Short Time Overload	JIS-C-5201-1 4.13 IEC-60115-1 4.13	Standard power : 6.25 times rated power whichever is less for 5 seconds. High power (2X/4X) and wide terminal type : 5 times rated power whichever is less for 5 seconds.	±(1.0%+0.001Ω)
Insulation Resistance	JIS-C-5201-1 4.8 IEC-60115-1 4.8	Apply 100VDC for 1 minute.	≥10GΩ
Dielectric Withstanding Voltage	JIS-C5201-1 4.7	0805 / 0612 and above applied 500VAC for 1 minute. 0201 / 0402 / 0603 applied 300VAC for 1 minute.	No short or burned on the appearance.
Core Body Strength	JIS-C5201-1 4.15	Central part pressurizing force : 10N , 10 seconds	No broken
Solderability	JIS-C-5201-1 4.17 IEC-60115-1 4.17	245±5°C for 3 seconds.	>95% Coverage No Visual damage
Resistance to Soldering Heat	JIS-C-5201-1 4.18 IEC-60115-1 4.18	260±5°C for 10 seconds.	±(1.0%+0.001Ω) No Visual damage
Leaching	JIS-C-5201-1 4.18 IEC-60068-2-58 8.2.1	260±5°C for 30 seconds.	>95% Coverage No Visual damage
Rapid Change of Temperature	JIS-C-5201-1 4.19 IEC-60115-1 4.19	-55°C to +155°C, 300 cycles	±(1.0%+0.001Ω) No Visual damage
Damp Heat with Load	JIS-C-5201-1 4.24 IEC-60115-1 4.24	40±2°C, 90~95% R.H. RCWV or Max. working current whichever is less for 1000 hrs with 1.5 hrs "ON" and 0.5 hr "OFF"	±(1.0%+0.001Ω)
Biased Humidity	MIL-STD-202 Method 103	1,000 hours; 85°C / 85% RH, 10% of operating power. Measurement at 24±4 hours after test conclusion.	±(0.5%+0.05Ω)
Load Life (Endurance)	JIS-C-5201-1 4.25 IEC-60115-1 4.25.1	70±2°C, Rated power, or Max. working current whichever is less for 1000 hrs with 1.5 hrs "ON" and 0.5 hr "OFF" .	±(1.0%+0.001Ω)
High Temperature Exposure	JIS-C5201-1 4.25 IEC 60068-2-2	At 155±5°C for 1000 +48/-0 hours.	±(1.0%+0.001Ω)
Resistance to Solvent	JIS-C-5201-1 4.29	The tested resistor be immersed into isopropyl alcohol of 20~25°C for 60 secs. Then the resistor is left in the room for 48 hrs.	±(1.0%+0.001Ω) No Visual damage
Terminal Strength	JIS-C5201-1 4.32 AEC Q200-006	Pressurizing force for 10 seconds 0201 / 0402 / 0603 : 8N ; 0805 / 0612 and above : 17.7N	No broken
Bending Strength	JIS-C-5201-1 4.33 IEC-60115-1 4.33	Bending once for 5 seconds D : 0201 / 0402 / 0603 / 0805 = 5mm 1206 / 1210 / 0612 = 3mm 2010 / 2512 / 1020 / 1225 = 2mm	±(1.0%+0.001Ω) No Visual damage

- Temperature Coefficient of Resistance test to - 55 °C is available on request
- We can also provide AEC-Q200 test reports if required by customers.



# TRL Series Metal Film Low-Resistance Chip Resistor Product Specifications

Document No.	S-10-12-13-11
Released Date	2020/4/07
Page No.	8/15

## ■ Marking

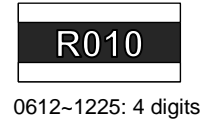
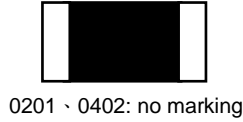

### ■ TRL0201 and TRL0402 : No marking

### ■ TRL0603 : 3 digit marking

#### 1. For E-24 values:

Resistance value	Code	Example
50mΩ ~ 99mΩ	0XX	068 = 68mΩ
100mΩ ~ 990mΩ	RXX	R68 = 680mΩ
1Ω ~ 9.9Ω	XRX	6R8 = 6.8Ω
10Ω	10R	10R = 10Ω

E-24	10	11	12	13	15	16	18	20	22	24	27	30	33	36	39	43	47	51	56	62	68	75	82	91
------	----	----	----	----	----	----	----	----	----	----	----	----	----	----	----	----	----	----	----	----	----	----	----	----

#### 2. For E-96 values: excluding values 10/11/13/15/20/75 of E-24 series.

##### ● Standard E-96 Values and 0603 Resistance Codes

R-Value	100	102	105	107	110	113	115	118	121	124	127	130	133	137	140	143	147	150	154	158	162	165	169	174
Code	01	02	03	04	05	06	07	08	09	10	11	12	13	14	15	16	17	18	19	20	21	22	23	24
R-Value	178	182	187	191	196	200	205	210	215	221	226	232	237	243	249	255	261	267	274	280	287	294	301	309
Code	25	26	27	28	29	30	31	32	33	34	35	36	37	38	39	40	41	42	43	44	45	46	47	48
R-Value	316	324	332	340	348	357	365	374	383	392	402	412	422	432	442	453	464	475	487	499	511	523	536	549
Code	49	50	51	52	53	54	55	56	57	58	59	60	61	62	63	64	65	66	67	68	69	70	71	72
R-Value	562	576	590	604	619	634	649	665	681	698	715	732	750	768	787	806	825	845	866	887	909	931	953	976
Code	73	74	75	76	77	78	79	80	81	82	83	84	85	86	87	88	89	90	91	92	93	94	95	96

##### ● E-96 Multiplier Code

Code	A	B	C	D	E	F	G	H	X	Y	Z
Multiplier	10 <sup>0</sup>	10 <sup>1</sup>	10 <sup>2</sup>	10 <sup>3</sup>	10 <sup>4</sup>	10 <sup>5</sup>	10 <sup>6</sup>	10 <sup>7</sup>	10 <sup>-1</sup>	10 <sup>-2</sup>	10 <sup>-3</sup>

0603 3 digits coding formula for E-96 values as following:

CODING FORMULA

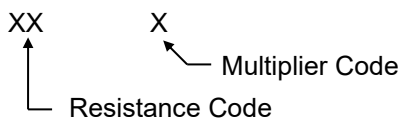

$$\text{Example: } 499 \text{ m}\Omega = \frac{499}{1000} \Omega = \frac{499}{10^3} \Omega = \mathbf{68Z}$$

68      Z





# TRL Series Metal Film Low-Resistance Chip Resistor Product Specifications

Document No.	S-10-12-13-11
Released Date	2020/4/07
Page No.	9/15

## ■ TRL0805 ~ TRL2512 : 4 digit marking

First 3 digits are the significant figures, the 4th digit is the multiplier. "R"= decimal point.

Examples:

Resistance value	Code	Example
50mΩ ~ 99mΩ (only for 0805,1206,1210)	R0XX	R068 = 68mΩ
100mΩ ~ 990mΩ	RXXX	R680 = 680mΩ
1Ω ~ 9.9Ω	XRXX	6R80 = 6.8Ω
10Ω	10R0	10R0 = 10Ω

## ■ TRL0612 ~ TRL1225 : 4 digit marking

First 3 digits are the significant figures, the 4th digit is the multiplier. "R"= decimal point.

Examples:

Resistance value	Code	Example
10 mΩ ~ 99 mΩ	R0XX	R010 = 10 mΩ
100 mΩ ~ 500 mΩ	RXXX	R100 = 100 mΩ

## ■ Recommended Customer Soldering Parameters

### ■ Wave solder Temperature condition

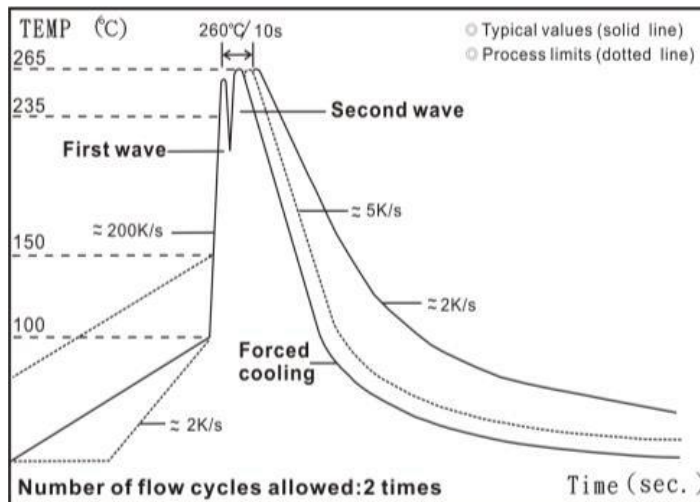



# TRL Series Metal Film Low-Resistance Chip Resistor Product Specifications

Document No.	S-10-12-13-11
Released Date	2020/4/07
Page No.	10/15

## ■ Solder reflow Temperature condition

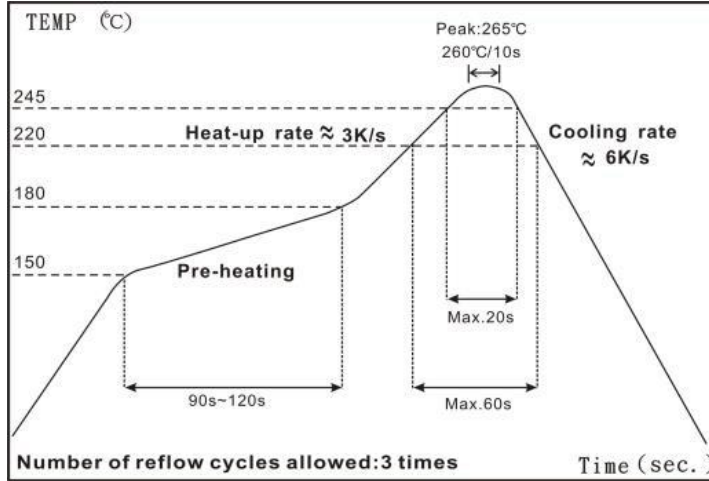

## ■ Rework temperature ( hot air equipment ) : 350°C, 3~5seconds

## ■ Recommended reflow methods

IR, vapor phase oven, hot air oven

If reflow temperatures exceed the recommended profile, devices may not meet the performance requirements.

■ **Recommend Land Pattern Design**

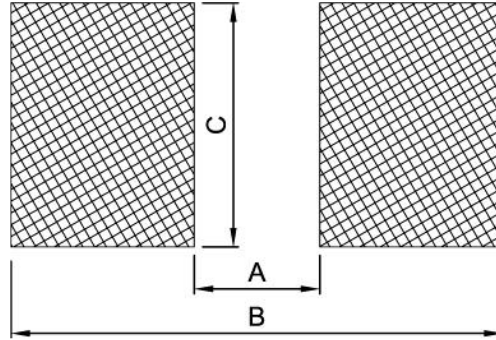

Unit: mm

TYPE	A	B	C
TRL0201	0.25	0.85	0.35
TRL0402	0.50	1.60	0.70
TRL0603	0.80	2.40	1.00
TRL0805	1.30	2.90	1.45
TRL1206	2.20	4.20	1.80
TRL1206 (10 mΩ ≤ R <39 mΩ)	1.20	4.80	1.84
TRL1210	2.00	4.40	2.70
TRL2010	3.80	6.60	2.70
TRL2512	4.90	8.10	3.40
TRL0612	0.50	2.60	3.20
TRL1020	1.00	4.05	5.50
TRL1225	1.20	5.20	7.00

■ **Plating Thickness**

Ni: ≥ 3 μm

Sn(Tin): ≥ 3 μm

■ Appendix For SMD Chip Resistor

■ Packaging Information

■ Reel Dimensions

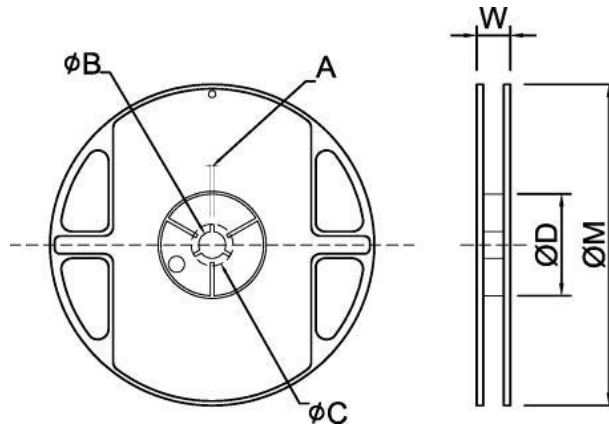

Unit: mm

TYPE	SIZE	A	φB	φC	φD	W	φM
TRL0201	7" 10K/Reel	2.0±0.5	13.5±1.0	21±1.0	60±1.0	11.5±2.0	178±2.0
TRL0402	7" 10K/Reel	2.0±0.5	13.5±1.0	21±1.0	60±1.0	11.5±2.0	178±2.0
TRL0603	7" 5K/Reel	2.0±0.5	13.5±1.0	21±1.0	60±1.0	11.5±2.0	178±2.0
TRL0805	7" 5K/Reel	2.0±0.5	13.5±1.0	21±1.0	60±1.0	11.5±2.0	178±2.0
TRL1206	7" 5K/Reel	2.0±0.5	13.5±1.0	21±1.0	60±1.0	11.5±2.0	178±2.0
TRL1210	7" 5K/Reel	2.0±0.5	13.5±1.0	21±1.0	60±1.0	11.5±2.0	178±2.0
TRL2010	7" 4K/Reel	2.0±0.5	13.5±1.0	21±1.0	60±1.0	11.5±2.0	178±2.0
TRL2512	7" 4K/Reel	2.0±0.5	13.5±1.0	21±1.0	60±1.0	16.0±2.0	178±2.0
TRL0612	7" 5K/Reel	2.0±0.5	13.5±1.0	21±1.0	60±1.0	11.5±2.0	178±2.0
TRL1020	7" 4K/Reel	2.0±0.5	13.5±1.0	21±1.0	60±1.0	11.5±2.0	178±2.0
TRL1225	7" 4K/Reel	2.0±0.5	13.5±1.0	21±1.0	60±1.0	16.0±2.0	178±2.0



**TRL Series Metal Film Low-Resistance Chip Resistor Product Specifications**

Document No.	S-10-12-13-11
Released Date	2020/4/07
Page No.	13/15

■ **Packaging Information**

■ **Tapping Specifications**

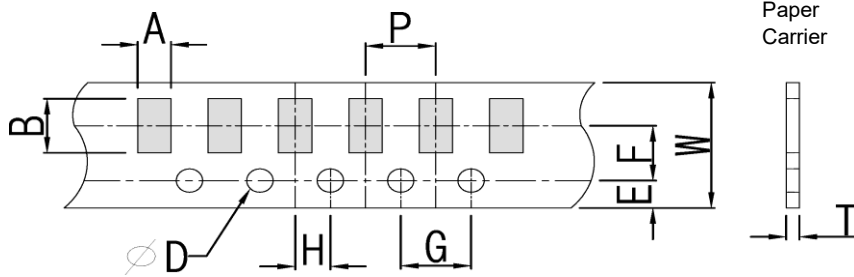

Unit: mm

Packaging	Type	A	B	W	E	F	G	H	T	ΦD	P
Paper Type	0201	0.45±0.1	0.75±0.1	8.0±0.2	1.75±0.1	3.5±0.05	4.0±0.1	2.0±0.05	0.35±0.1	1.50 <sup>+0.1</sup> <sub>0</sub>	2.0±0.1
	0402	0.7±0.1	1.20±0.1	8.0±0.2	1.75±0.1	3.5±0.05	4.0±0.1	2.0±0.05	0.45±0.1		2.0±0.1
	0603	1.05±0.2	1.80±0.2	8.0±0.2	1.75±0.1	3.5±0.05	4.0±0.1	2.0±0.05	0.60±0.1		4.0±0.1
	0805	1.55±0.2	2.30±0.2	8.0±0.2	1.75±0.1	3.5±0.05	4.0±0.1	2.0±0.05	0.75±0.1		4.0±0.1
	1206	1.90±0.2	3.05±0.2	8.0±0.2	1.75±0.1	3.5±0.05	4.0±0.1	2.0±0.05	0.75±0.1		4.0±0.1
	1210	2.85±0.2	3.05±0.2	8.0±0.2	1.75±0.1	3.5±0.05	4.0±0.1	2.0±0.05	0.75±0.1		4.0±0.1
	0612	2.85±0.2	3.05±0.2	8.0±0.2	1.75±0.1	3.5±0.05	4.0±0.1	2.0±0.05	0.75±0.1		4.0±0.1

■ **Embossed Dimensions**

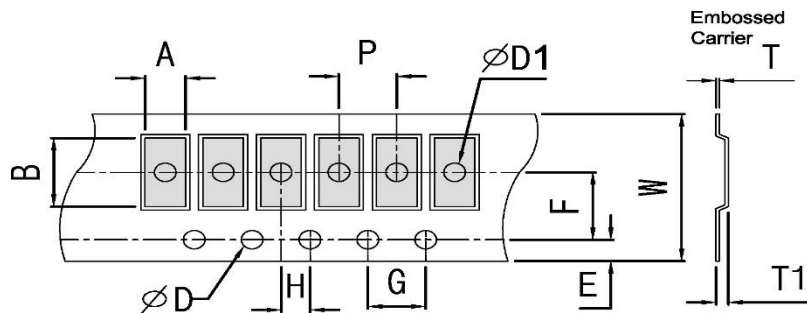



**TRL Series Metal Film Low-Resistance Chip Resistor Product Specifications**

Document No. S-10-12-13-11  
 Released Date 2020/4/07  
 Page No. 14/15

Unit: mm

Packaging	Type	A	B	W	E	F	G	H	T	ΦD	ΦD1	T1	P
Embossed Type	2010	2.80±0.2	5.60±0.2	12±0.1	1.75±0.1	5.5±0.05	4.0±0.1	2.0±0.05	0.23±0.1	1.50 <sup>+0.1</sup> <sub>0</sub>	1.50±0.1	0.85±0.15	4.0±0.1
	2512	3.40±0.2	6.70±0.2	12±0.1	1.75±0.1	5.5±0.05	4.0±0.1	2.0±0.05	0.23±0.1		1.50±0.1	0.85±0.15	4.0±0.1
	1020	2.80±0.2	5.60±0.2	12±0.1	1.75±0.1	5.5±0.05	4.0±0.1	2.0±0.05	0.23±0.1		1.50±0.1	0.85±0.15	4.0±0.1
	1225	3.40±0.2	6.70±0.2	12±0.1	1.75±0.1	5.5±0.05	4.0±0.1	2.0±0.05	0.23±0.1		1.50±0.1	0.85±0.15	4.0±0.1

■ Packing Material Data / Storage Data

■ Front & Back Lead Dimensions

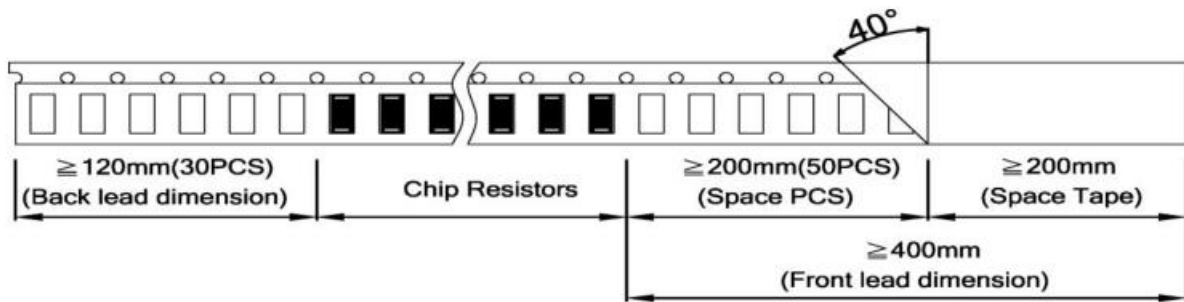

■ Top Adhesive Peel Off Strength : 10~70g

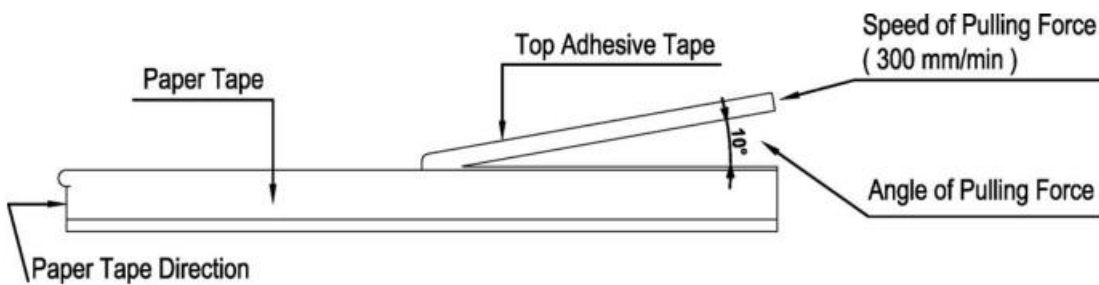



# TRL Series Metal Film Low-Resistance Chip Resistor Product Specifications

Document No.	S-10-12-13-11
Released Date	2020/4/07
Page No.	15/15

## ■ Package

Inner Box Size	
Reel	Size H(mm)
1	13
2	24
3	36
5	60
10	113

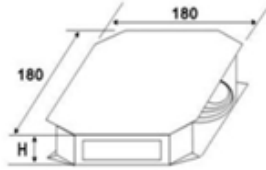

External Box Size			
Contain (Kpcs)	Length (mm)	Width (mm)	Width (mm)
25K	180	180	60
50K	180	180	110
150K	430	200	200
300K	400	400	200

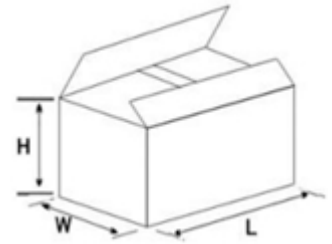

## ■ Storage Data :

Storage time at the environment temp:  $25\pm 5^{\circ}\text{C}$  & humidity:  $60\pm 20\%$  is valid for one year from the date of delivery.